

RUČKICE I VJEŠALICE

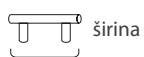

Kotiranje i šifre proizvoda

RUČKE



širina

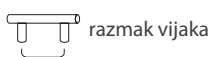

razmak vijaka



visina



širina



količina u pakiranju

GUMBI



promjer



visina



količina u pakiranju

UKOPNE RUČKE



vanjske dimenzije



unutarnje dimenzije



dubina



razmak vijaka



količina

VJEŠALICE



visina



razmak



širina



dubina



količina

ŠIFRE:

Ručka = Artikl + razmak + površinska obrada

Gumb = Artikl + površinska obrada

Vješalica = Artikl + površinska obrada

Ukopna ručka = Artikl + površinska obrada

„FO” ručke i vješalice imaju jedinstvenu šifru za površinsku obradu (vidi u tablici artikl)

Površinska obrada

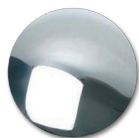

KR
krom



MNIG
mat nikal



MNI
mat nikal

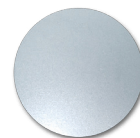

MKR
mat krom



MKRG
mat krom



SAT
saten



MZL
mat zlatna



BE
bijela

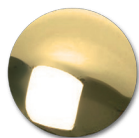

ZL
zlatna



INOX
inoks



CR
crna







CRM
crna mat





EL
eloksirano

Ručke







Artikl					
RH70055	136	128	27	8	40
	167	160	27	8	40
	199	192	27	8	20
	327	320	27	8	20

POVRŠINSKE OBRADÉ

-  MKR MAT KROM
-  MS MAT SIVA - GRAFIT



Artikl					
RH71121	138	128	27	10	25
	170	160	27	10	25

POVRŠINSKE OBRADÉ

-  MC MAT CRNA

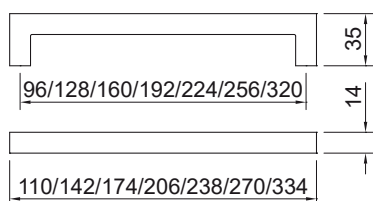

Artikl	Naziv
FO7652300	Ručkica E064-160 INOX
FO7652310	Ručkica E064-192, INOX
FO7652330	Ručkica E064-256, INOX
FO7652340	Ručkica E064-320, INOX

POVRŠINSKE OBRADÉ

-  INOX

Ručke



Artikl					
RH71016	114	96	28	9	25
	152	128	28	9	25
	190	160	28	9	25
	226	192	28	9	25
	258	224	28	9	25

POVRŠINSKE OBRADE

- BSN BRUŠEN SATEN NIKL
- MC MAT CRNA
- MKR MAT KROM

* Samo MKR

Zamjena za E081 ručku



Artikl					
RL2226	227	192	28	-	20

POVRŠINSKE OBRADE

- MKR MAT KROM
- C CRNA
- MNI MAT NIKL

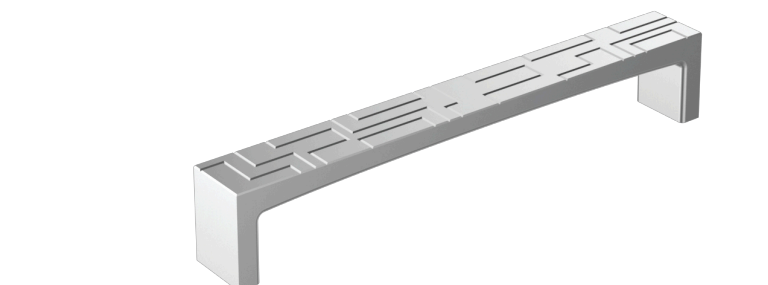





Artikl					
RL2439	164	160	29	-	20

POVRŠINSKE OBRADE

- MKR MAT KROM







Artikl					
RH71004	168	160	29	25	50
	200	192	29	25	50
	232	224	29	25	25
	328	320	29	25	25

POVRŠINSKE OBRADÉ

 MKR MAT KROM







Artikl					
RH7230	137	128	32	8	50

POVRŠINSKE OBRADÉ

 BN BRUŠEN NIKL



Artikl					
RH71446	171	160	30	10	25

POVRŠINSKE OBRADÉ

 BSN BRUŠEN SATEN NIKL

Ručke



Artikl					
RH71013	150	128	30	18	50
	180	160	30	18	50
	214	192	30	18	50

POVRŠINSKE OBRADJE

- MKR MAT KROM

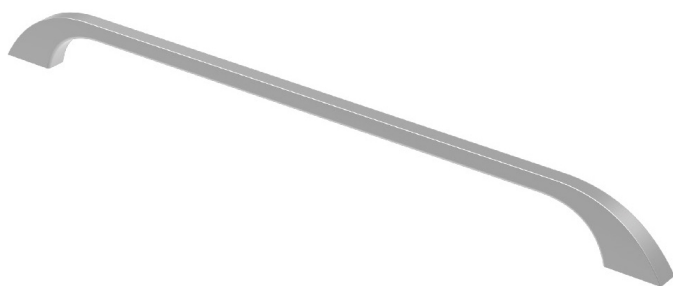

Artikl					
RL2455	356	320	30	-	20

POVRŠINSKE OBRADJE

- MKR MAT KROM
- C CRNA
- KR KROM
- MNI MAT NIKL



Artikl					
RL2457	195	160	30	-	20

POVRŠINSKE OBRADJE

- MKR MAT KROM
- C CRNA
- KR KROM
- MNI MAT NIKL

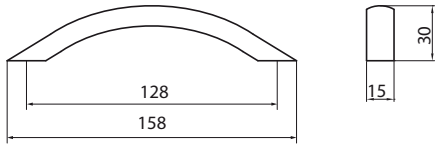

Artikl	Naziv
FO7653210	Ručkica A021-128 Aluminij

POVRŠINSKE OBRAD

● AL ALUMINIJ

Artikl					
RH70701	106	96	24	9	100
	148	128	24	9	50

POVRŠINSKE OBRAD

● MKR MAT KROM

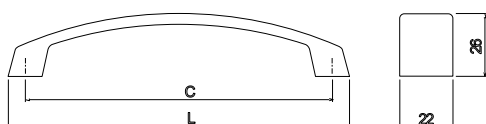

Zamjena za E002 ručku

Ručke



Artikl	Naziv
THR61-128IN	RUČKICA 61 128mm - inox
THR61-160IN	RUČKICA 61 160mm - inox
THR61-192IN	RUČKICA 61 192mm - inox
THR61-128C	Ručkica 61 128mm - crna
THR61-160C	Ručkica 61 160mm - crna
THR61-192C	Ručkica 61 192mm - crna

POVRŠINSKE OBRADJE

-  IN INOX
-  TITANIUM CRNA

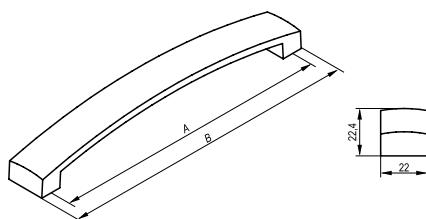

Artikl	Naziv
RJTYTANO128ZL	Ručkica Tytano, 141/128, h=22,4, brušeno zlato
RJTYTANO160ZL	Ručkica Tytano, 173/160, h=22,4, brušeno zlato
RJTYTANO192ZL	Ručkica Tytano, 205/192, h=22,4, brušeno zlato
RJTYTANO256ZL	Ručkica Tytano, 269/256, h=22,4, brušeno zlato
RJTYTANO320ZL	Ručkica Tytano, 333/320, h=22,4, brušeno zlato

POVRŠINSKE OBRADJE

-  ZLATO BRUŠENO



Artikl					
RH71267	260	224	28	15	25
	196	160	26	14	30

POVRŠINSKE OBRADE

- BSN BRUŠEN SATEN NIKL
- MKR MAT KROM

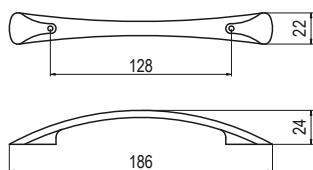

Artikl	Naziv
FO7650490	Ručkice E008-128 KROM
FO7650493	Ručkice E008-128 MKR

POVRŠINSKE OBRADE

- KR KROM
- MKR MAT KROM

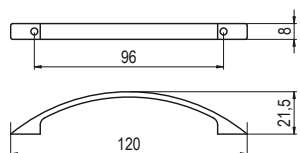

Artikl	Naziv
FO7601375	Ručkica T 250--096 mat krom

POVRŠINSKE OBRADE

- MKR MAT KROM

Ručke

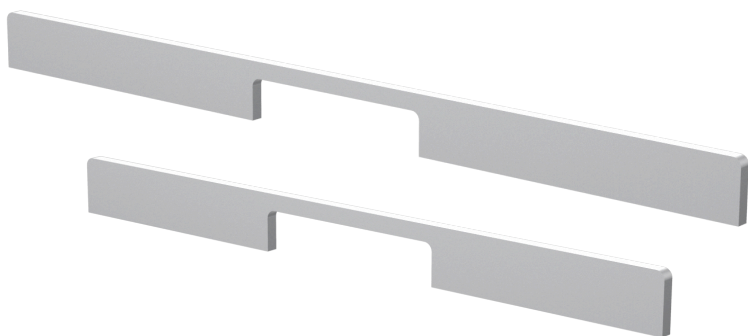

Artikl					
RL2479	284	224	35	7	10
	380	320	35	7	10
	476	416	35	7	10
	572	512	35	7	10

POVRŠINSKE OBRADE

AL ALUMINIJ



Artikl	Naziv
THRRAY128BZ	Ručkica RAY 128 mm, četkano zlato
THRRAY128C	Ručkica RAY 128 mm, crna
THRRAY128GS	Ručkica RAY 128 mm, grafit siva
THRRAY192BZ	Ručkica RAY 192 mm, četkano zlato
THRRAY192C	Ručkica RAY 192 mm, crna
THRRAY192GS	Ručkica RAY 192 mm, grafit siva
THRRAY320BZ	Ručkica RAY 320 mm, četkano zlato
THRRAY320C	Ručkica RAY 320 mm, crna
THRRAY320GS	Ručkica RAY 320 mm, grafit siva



Artikl	Naziv
THRRAYGBZ	Dugme ručkica RAY, ZnAl, četkano zlato
THRRAYGC	Dugme ručkica RAY, ZnAl, crna
THRRAYGGS	Dugme ručkica RAY, ZnAl, grafit siva

POVRŠINSKE OBRADE

ZLATO BRUŠENO

CRNA

GRAFIT

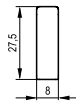
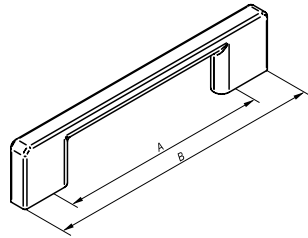

Artikl	Naziv
RJEASY96ZL	Ručkica Easy, 130/96, h=27,5, brušeno zlato
RJEASY128ZL	Ručkica Easy, 161/128, h=27,5, brušeno zlato
RJEASY160ZL	Ručkica Easy, 192/160, h=27,5, brušeno zlato
RJEASY192ZL	Ručkica Easy, 225/192, h=27,5, brušeno zlato
RJEASY256ZL	Ručkica Easy, 290/256, h=27,5, brušeno zlato
RJEASY320ZL	Ručkica Easy, 354/320, h=27,5, brušeno zlato

POVRŠINSKE OBRADJE

● ZLATO BRUŠENO

Ručke



Artikl					
RH12	188	128	32	12	50
	220	160	32	12	50
	252	192	32	12	50
	284	224	32	12	50
	348	288	32	12	50
	380	320	32	12	50

POVRŠINSKE OBRADJE

SS SATEN ČETKAN



Artikl					
RH72278	168	128	33	14	25
	232	192	33	14	25

POVRŠINSKE OBRADJE

MC MAT CRNA

SS SATEN ČETKAN

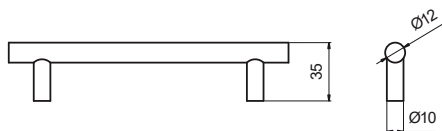

Artikl	Naziv
FO7650876	RUČKICA E037-096 NIKL
FO7650880	RUČKICA E037-128 NIKL
FO7650890	RUČKICA E037-160 NIKL
FO7650892	RUČKICA E037-192 NIKL
FO7650897	RUČKICA E037-256 NIKL
FO7650900	RUČKICA E037-288 NIKL
FO7650905	RUČKICA E037-320 NIKL
FO7650915	RUČKICA E037-384 NIKL
FO7650920	RUČKICA E037-448 NIKL
FO7650930	RUČKICA E037-560 NIKL
FO7650940	RUČKICA E037-660 NIKL
FO7650950	RUČKICA E037-760 NIKL

POVRŠINSKE OBRADJE

NI NIKL

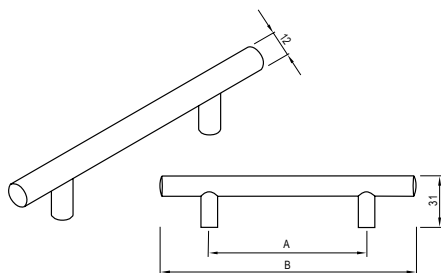

Artikl	Naziv
RJRR096C	Reling ručkica, 156/96mm, crna
RJRR128C	Reling ručkica, 188/128mm, crna
RJRR160C	Reling ručkica, 220/160mm, crna
RJRR192C	Reling ručkica, 272/192mm, crna
RJRR224C	Reling ručkica, 304/224mm, crna
RJRR256C	Reling ručkica, 356/256mm, crna
RJRR288C	Reling ručkica, 368/288mm, crna
RJRR320C	Reling ručkica, 400/320mm, crna

POVRŠINSKE OBRAD

● CRNA



Ručke

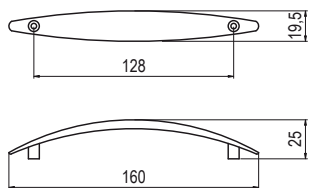
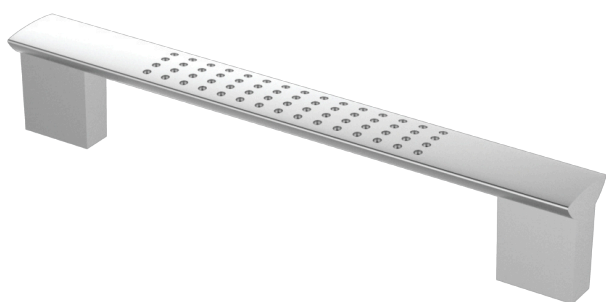
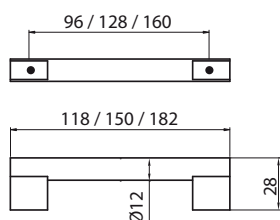
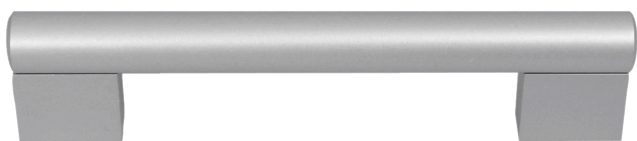

Artikl	Naziv
FO7653040	Ručkica A015-128 ALU
FO7653050	Ručkica A015-160 ALU

POVRŠINSKE OBRADJE

● AL ALUMINIJ

Artikl					
RL2294	143	128	26	13	20

POVRŠINSKE OBRADJE

● MKR MAT KROM

Artikl	Naziv
FO7610010	Ručkica T255-128 mat krom

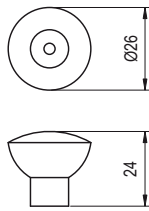

POVRŠINSKE OBRADJE

● MKR MAT KROM



Artikl	Naziv
FO7601389	Ručkica T 252-28 krom
FO7601390	Ručkica T 252-28 mat krom
FO7601393	Ručkica T 252-28 mat nikl

POVRŠINSKE OBRADE

-  KR KROM
-  MKR MAT KROM
-  MNI MAT NIKL

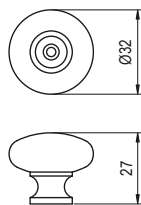

Artikl	Naziv
FO7650560	Ručkice E013- 032 KROM
FO7650561	Ručkice E013- 032 NIKL

POVRŠINSKE OBRADE

-  KR KROM
-  NI NIKL

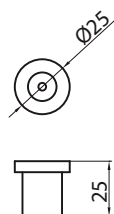

Artikl	Naziv
FO7653190	Ručkica A020-025 ALU

POVRŠINSKE OBRADE

-  AL ALUMINIJ

Ručke

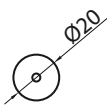

Artikl	Naziv
FO7653170	Ručkica A019-020 ALU

POVRŠINSKE OBRADJE

● AL ALUMINIJ



Artikl			
RH70154	27	23	80

POVRŠINSKE OBRADJE

● MKR MAT KROM

● C CRNA

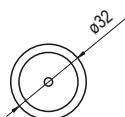

Artikl	Naziv
FO7801100	Ručkica P 91/B-32 gumb, bijela plastika
FO7801200	Ručkica P 91/B-32 gumb, crna plastika

POVRŠINSKE OBRADJE

● CRNA

● BIJELA





Artikl	Naziv
THSPOTBZ	Ručkica/gumb Spot, brušeno zlato, fi24
THSPOTC	Ručkica/gumb Spot, crna, fi24
THSPOTI	Ručkica/gumb Spot, inox, fi24

POVRŠINSKE OBRAD

-  ZLATO BRUŠENO
-  CRNA
-  INOX

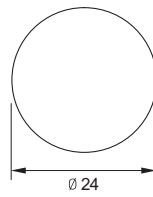
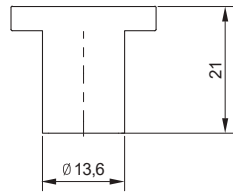

Ručke ukopne



Artikl	Naziv
THRB224ALU	Ručkica B224 - alu
THRB224B	Ručkica B224 - bijela
THRB224C	Ručkica B224 - crna

POVRŠINSKE OBRADE

-  AL ALUMINIJ
-  C CRNA
-  B BIJELA

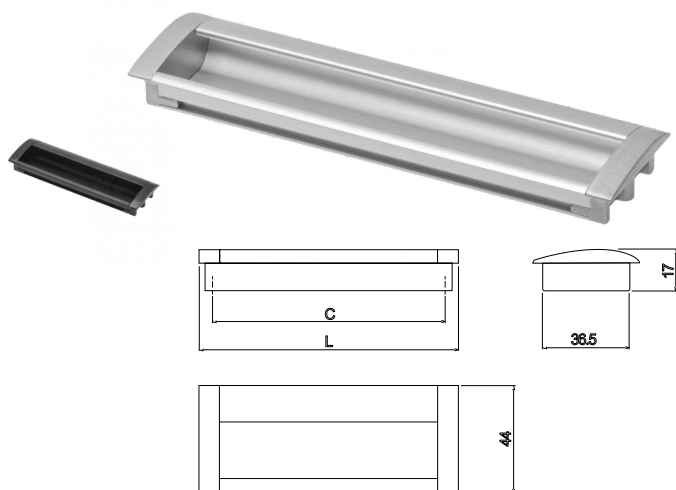

Artikl	Naziv
THRU326-128ALU	RUČKICA UKOPNA 326 128mm - alu
THRU326-128C	RUČKICA UKOPNA 326 128mm - crna
THRU326-160ALU	RUČKICA UKOPNA 326 160mm - alu
THRU326-160C	RUČKICA UKOPNA 326 160mm - crna



POVRŠINSKE OBRADE

-  AL ALUMINIJ
-  C CRNA







Artikl	Naziv
THRU306-128ALU	RUČKICA UKOPNA 306 128mm - alu
THRU306-128INOX	RUČKICA UKOPNA 306 128mm - inox
THRU306-160ALU	RUČKICA UKOPNA 306 160mm - alu
THRU306-160INOX	RUČKICA UKOPNA 306 160mm - inox

POVRŠINSKE OBRADE

-  AL ALUMINIJ
-  IN INOX

Ručke rustik







Artikl					
RH73173	74	64	20	31	35

POVRŠINSKE OBRAD

 AM ANTIK MIJED





Artikl					
RH72503	128	96	32	15	35

POVRŠINSKE OBRAD

 AM ANTIK MIJED

 AS ANTIK SREBRNA



Artikl			
RH75033	26	28	50

POVRŠINSKE OBRAD

 AM ANTIK MIJED

 AS ANTIK SREBRNA

Ručke rustik

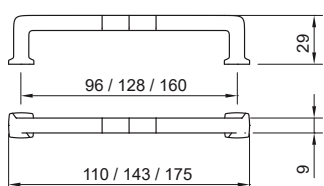
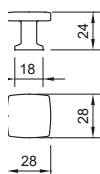
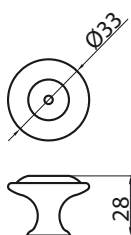
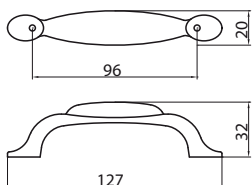

Artikl	Naziv
FO7652052	Ručkica EO52/96 PATI.BRONCA-PŠE

POVRŠINSKE OBRADE

● AM ANTIK MIJED

Artikl	Naziv
FO7652062	Ručkica EO53/33 PATI.BRONCA-PŠE

POVRŠINSKE OBRADE



● AM ANTIK MIJED

Artikl	Naziv
FO7553000	RUČKA 780, 160 PATINIRANA FIRENZA
FO7553025	GUMB 780, 28x28 PATINIRANA FIRENZA

POVRŠINSKE OBRADE

● PAT PATINA (STARO ZLATO)





Artikl			
RL2207	30	22	20

POVRŠINSKE OBRAD

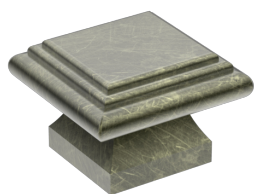
 PAT PATINA (STARO ZLATO)







Artikl			
RL2365	35	24	20

POVRŠINSKE OBRAD

 PAT PATINA (STARO ZLATO)



Artikl					
RL2341	127	96	29	12	20

POVRŠINSKE OBRAD

 PAT PATINA (STARO ZLATO)

Ručke profilne



Artikl					
RL2321	167	128	22	13	20

POVRŠINSKE OBRAD

PAT PATINA (STARO ZLATO)

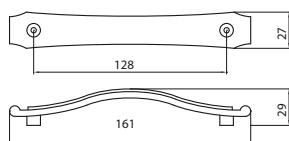

Artikl	Naziv
FO7551641	RUČKICA 628-224 FIRENZE PATINAS
FO7551642	RUČKICA 628-128 FIRENZE PATINAS
FO7551643	RUČKICA 628-96 FIRENZE PATINAS

POVRŠINSKE OBRAD

PAT PATINA (STARO ZLATO)

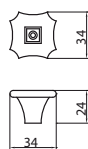





Artikl	Naziv
FO7551645	RUČKICA 628-000 FIRENZE PATINAS

POVRŠINSKE OBRAD

PAT PATINA (STARO ZLATO)



Artikl					
RL2403	195	-	17	34	10
	295	-	17	34	10
	395	-	17	34	10
	495	-	17	34	10
	595	-	17	34	10
	695	-	17	34	10
	795	-	17	34	10
	895	-	17	34	10

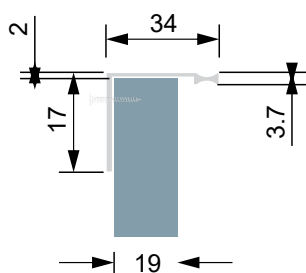
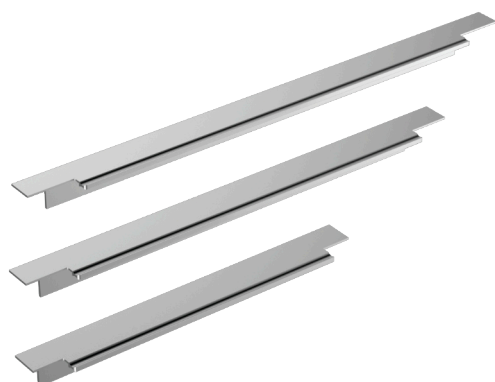

POVRŠINSKE OBRADE

 AL ALUMINIJ



Artikl	Naziv
THP22-296MC	RUČKICA P22 296/18 MAT CRNA
THP22-396MC	RUČKICA P22 396/18 MAT CRNA
THP22-496MC	RUČKICA P22 496/18 MAT CRNA
THP22-596MC	RUČKICA P22 596/18 MAT CRNA

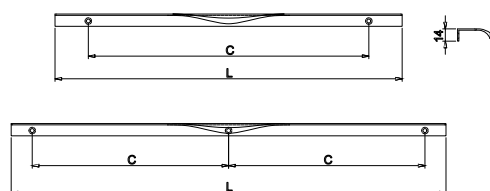

POVRŠINSKE OBRADE



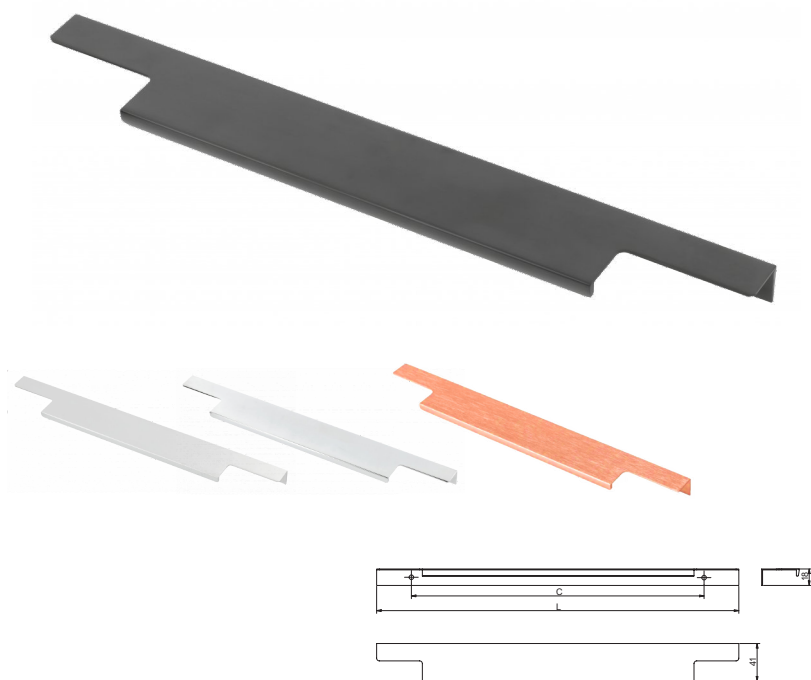

 C CRNA

Ručke profilne



Artikl	Naziv
THP21-296ALU	RUČKICA P21 296/18 ALU
THP21-396ALU	RUČKICA P21 396/18 ALU
THP21-496ALU	RUČKICA P21 496/18 ALU
THP21-596ALU	RUČKICA P21 596/18 ALU
THP21-796ALU	RUČKICA P21 796/18 ALU
THP21-296KR	RUČKICA P21 296/18 KROM
THP21-396KR	RUČKICA P21 396/18 KROM
THP21-496KR	RUČKICA P21 496/18 KROM
THP21-596KR	RUČKICA P21 596/18 KROM
THP21-796KR	RUČKICA P21 796/18 KROM
THP21-296MC	RUČKICA P21 296/18 MAT CRNA
THP21-396MC	RUČKICA P21 396/18 MAT CRNA
THP21-496MC	RUČKICA P21 496/18 MAT CRNA
THP21-596MC	RUČKICA P21 596/18 MAT CRNA
THP21-796MC	RUČKICA P21 796/18 MAT CRNA
THP21-296ZL	RUČKICA P21 296/18 BRUŠENO ZLAŤO
THP21-396ZL	RUČKICA P21 396/18 BRUŠENO ZLAŤO
THP21-496ZL	RUČKICA P21 496/18 BRUŠENO ZLAŤO
THP21-596ZL	RUČKICA P21 596/18 BRUŠENO ZLAŤO
THP21-796ZL	RUČKICA P21 796/18 BRUŠENO ZLAŤO

POVRŠINSKE OBRAD

-  AL ALUMINIJ
-  C CRNA
-  KR KROM
-  ZL BRUŠENO ZLAŤO (CRVENO ZLAŤO)

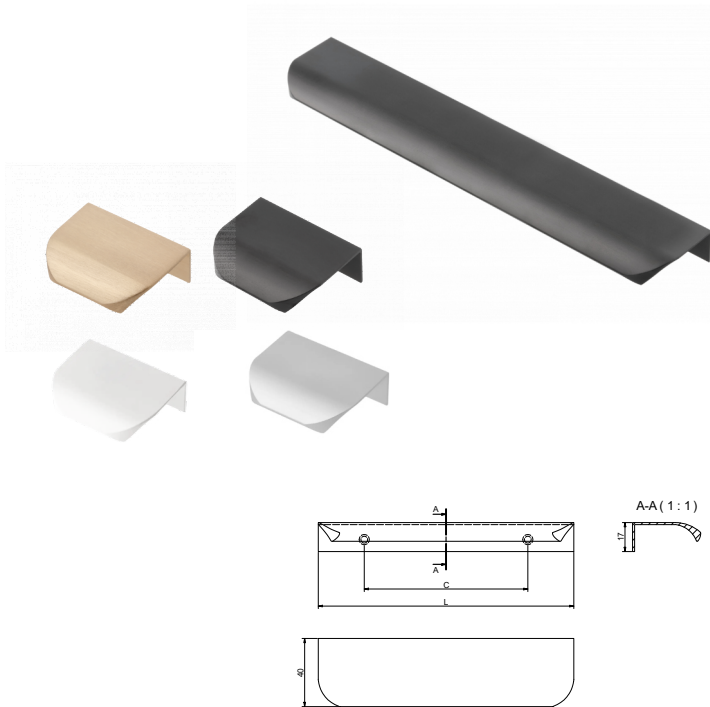

Artikl	Naziv
THP23-32ALU	Ručkica P23 32mm, aluminij
THP23-32B	Ručkica P23 32mm, bijela
THP23-32C	Ručkica P23 32mm, crna
THP23-32ZL	Ručkica P23 32mm, zlato
THP23-96ALU	Ručkica P23 96mm, aluminij
THP23-96B	Ručkica P23 96mm, bijela
THP23-96C	Ručkica P23 96mm, crna
THP23-96ZL	Ručkica P23 96mm, zlato
THP23-192ALU	Ručkica P23 192mm, aluminij
THP23-192B	Ručkica P23 192mm, bijela
THP23-192C	Ručkica P23 192mm, crna
THP23-192ZL	Ručkica P23 192mm, zlato
THP23-352ALU	Ručkica P23 duga - 1.200mm, ALU
THP23-352B	Ručkica P23 duga - 1.200mm, BIJELA
THP23-352C	Ručkica P23 duga - 1.200mm, CRNA
THP23-352ZL	Ručkica P23 duga - 1.200mm, ZLATO

POVRŠINSKE OBRADJE

- AL ALUMINIJ
- C CRNA
- BIJELA
- ZL ZLATO

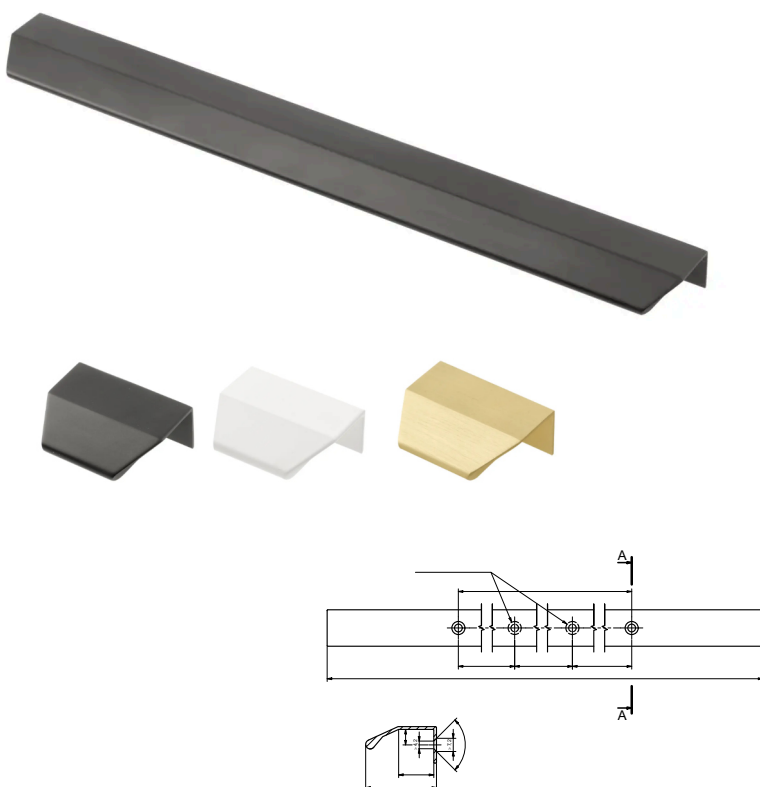

Artikl	Naziv
THP24-32B	Ručkica P24 32mm, bijela
THP24-32C	Ručkica P24 32mm, crna
THP24-32ZL	Ručkica P24 32mm, zlato
THP24-320B	Ručkica P24 320mm, bijela
THP24-320C	Ručkica P24 320mm, crna
THP24-320ZL	Ručkica P24 320mm, zlato
THP24-352B	Ručkica P24 duga - 1.200mm, bijela
THP24-352C	Ručkica P24 duga - 1.200mm, crna
THP24-352ZL	Ručkica P24 duga - 1.200mm, zlato

Ručke profilne

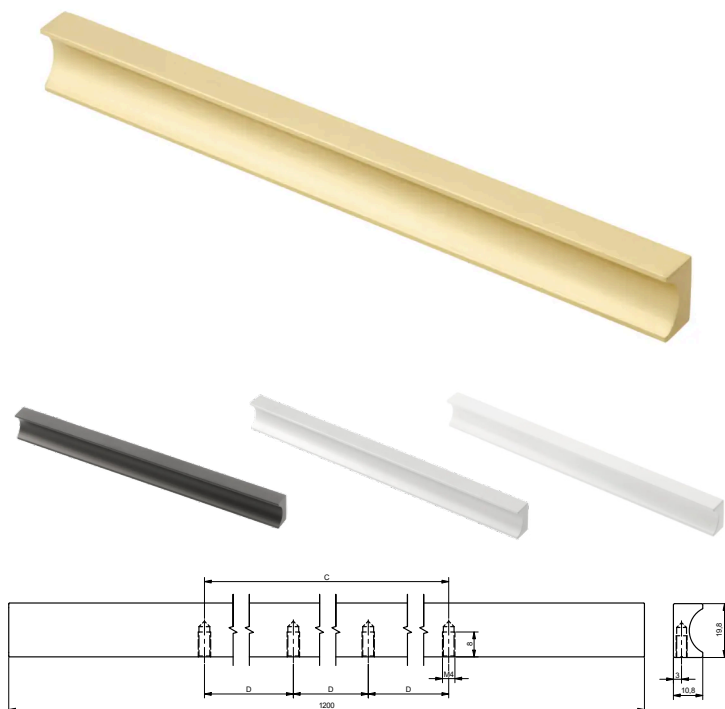

Artikl	Naziv
THP26-160ALU	Ručkica P26 160 mm, aluminij
THP26-160B	Ručkica P26 160 mm, bijela
THP26-160C	Ručkica P26 160 mm, crna
THP26-160ZL	Ručkica P26 160 mm, zlato
THP26-320ALU	Ručkica P26 320 mm, aluminij
THP26-320B	Ručkica P26 320 mm, bijela
THP26-320C	Ručkica P26 320 mm, crna
THP26-320ZL	Ručkica P26 320 mm, zlato
THP26-352ALU	Ručkica P26 duga - 1.200 mm, aluminij
THP26-352B	Ručkica P26 duga - 1.200 mm, bijela
THP26-352C	Ručkica P26 duga - 1.200 mm, crna
THP26-352ZL	Ručkica P26 duga - 1.200 mm, zlato



POVRŠINSKE OBRADJE

-  AL ALUMINIJ
-  C CRNA
-  BIJELA
-  ZL ZLATO



Artikl	Naziv
THLPAF3500ALU	RUČKICA PROFILNA L oblik za frezanje (L=3,5m) - ALU
THLPAF3500C	RUČKICA PROFILNA L oblik za frezanje (L=3,5m) - CRNA

POVRŠINSKE OBRADJE

-  AL ALUMINIJ
-  C CRNA

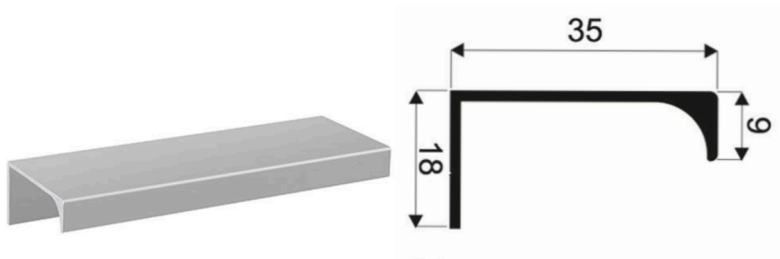

Artikl	Naziv
SVG8063000	Profilirana ručkica 806, ALU (3 m), 18x35

POVRŠINSKE OBRADJE

- AL ALUMINIJ

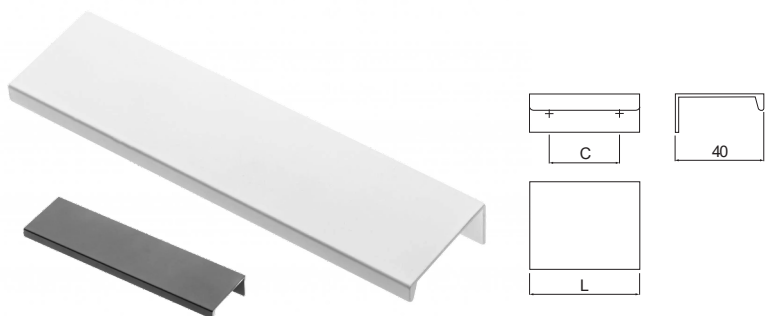

Artikl	Naziv
THP08-3500ALU	Ručkica Profil08 3500mm - alu
THP08-3500C	Ručkica Profil08 3500mm - crna

POVRŠINSKE OBRADJE

- AL ALUMINIJ
- C CRNA

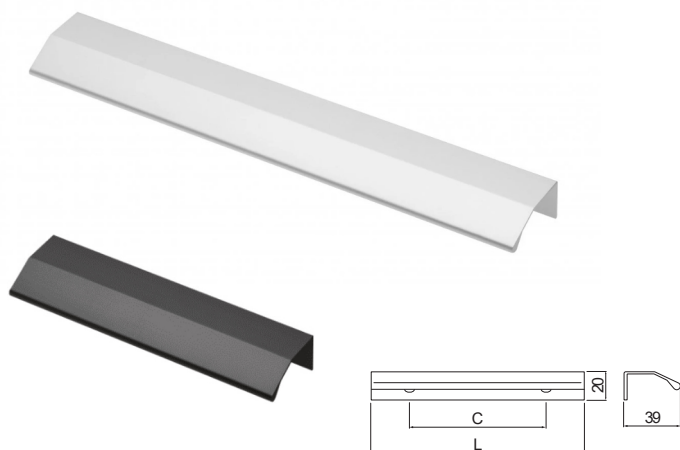

Artikl	Naziv
THP09-3500ALU	RUČKICA PROFIL09 3500mm - alu
THP09-3500C	RUČKICA PROFIL09 3500mm - crna

POVRŠINSKE OBRADJE

- AL ALUMINIJ
- C CRNA

Ručke profilne

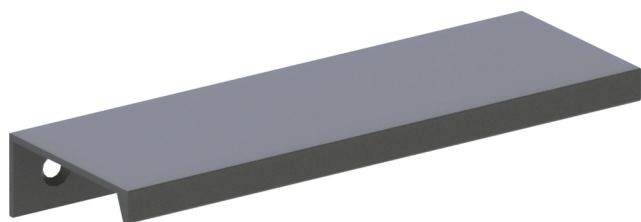

Artikl	Naziv
RJAL932GR	Ručkica AL9, 52/32, grafit
RJAL996GR	Ručkica AL9, 116/96, grafit
RJAL9128GR	Ručkica AL9, 148/128, grafit
RJAL9192GR	Ručkica AL9, 212/192, grafit

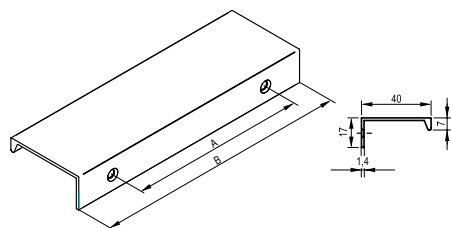

Vješalice

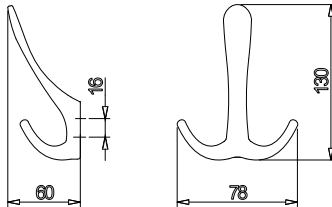

Artikl	Naziv
THV003C	Vješalica 003, crna
THV003KR	Vješalica 003, krom
THV003IN	Vješalica 003, INOX

POVRŠINSKE OBRADJE

-  C CRNA
-  KR KROM
-  IN INOX

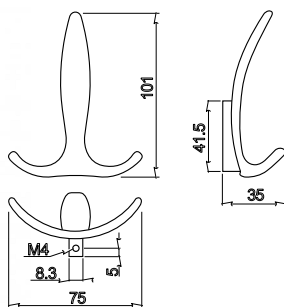





Artikl	Naziv
THV018C	Vješalica 018, crna
THV018KR	Vješalica 018, krom
THV018MKR	Vješalica 018, mat krom
THV018SAT	Vješalica 018, saten

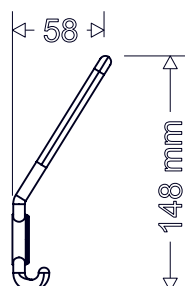

POVRŠINSKE OBRADJE

-  MKR MAT KROM
-  C CRNA
-  KR KROM
-  SAT SATEN



Artikl					
VL7003	148	-	50	58	20

POVRŠINSKE OBRADJE

-  MKR MAT KROM
-  C CRNA

Vješalice

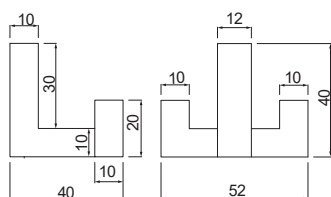
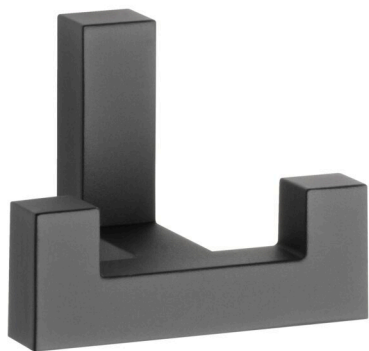

Artikl	Naziv
THVK2202C	Vješalica K2202, crna
THVK2202I	Vješalica K2202, inox

POVRŠINSKE OBRAD



C CRNA



IN INOX

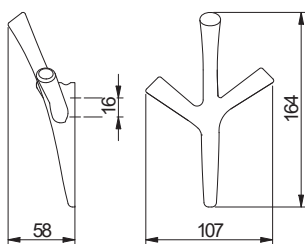

Artikl	Naziv
THV004CM	Vješalica 004, crna matt
THV004INOX	Vješalica 004, inox

POVRŠINSKE OBRAD



C CRNA



IN INOX



Artikl					
OH28101	132	20	75	77	30

POVRŠINSKE OBRADE

MKR MAT KROM



Artikl					
OH28105	90	14	24	63	50

POVRŠINSKE OBRADE

MKR MAT KROM



Artikl	Naziv
OH28109MKR	Vješalica 28109 mat krom
TH28109C	Vješalica 28109, Crna

POVRŠINSKE OBRADE

MKR MAT KROM

C CRNA



Artikl	Naziv
OH28107MKR	Vješalica 28107 mat krom
TH28107C	Vješalica 28107, Crna

POVRŠINSKE OBRADE

MKR MAT KROM

C CRNA

Profili Gola

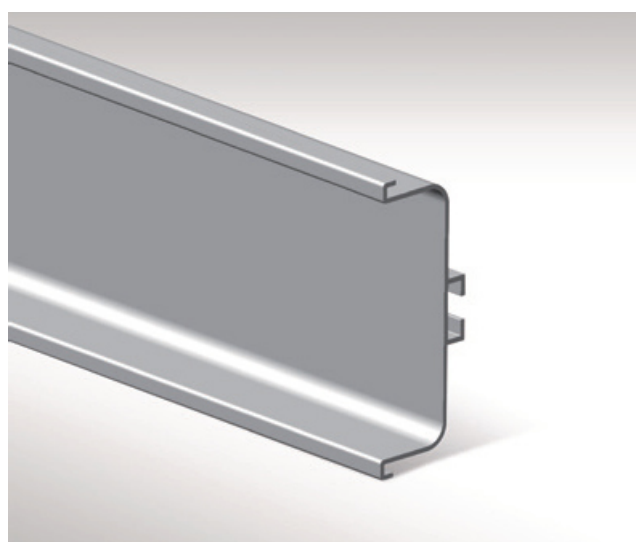
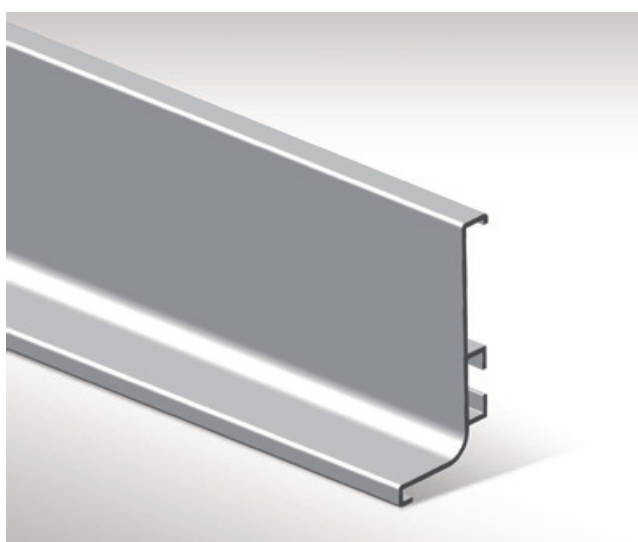

Gola profil L - 4,1 m

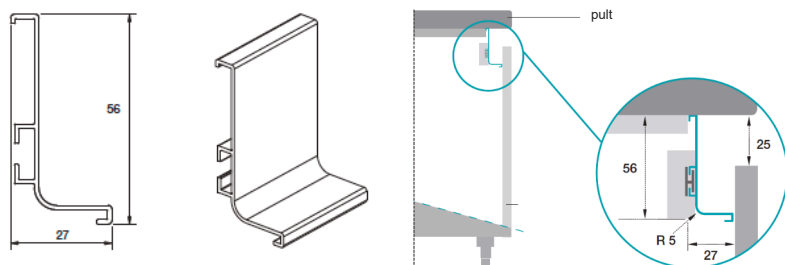

vrata

Artikl	Naziv	JM
OPGLPAL	Opes Gola profil L, ALU (4,1 tm)	TM
OPGLPB	Opes Gola profil L, BIJELA (4,1 tm)	TM
OPGLPC	Opes Gola profil L, CRNI (4,1 tm)	TM
OPGLPANT	Opes Gola profil L, ANTRACIT (4,1 tm)	TM
OPGLPZL	Opes Gola profil L, ZLATNI (4,1 tm)	TM

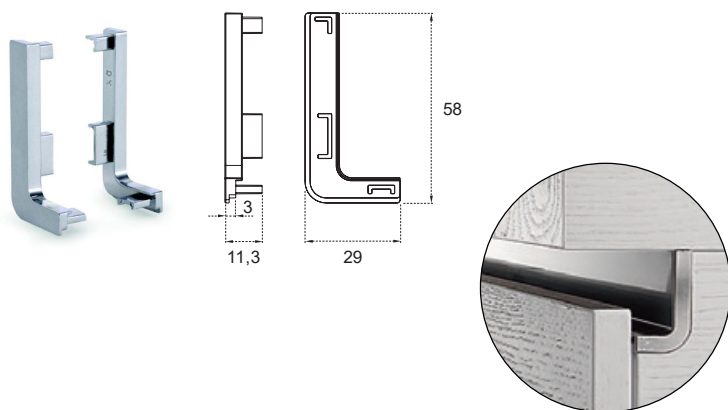

Artikl	Naziv	JM
OPGLZ	Završetak za GOLA L (L+D) - ALU	KPL
OPGLZB	Završetak za GOLA L (L+D) - BIJELI	KPL
OPGLZC	Završetak za GOLA L (L+D) - CRNI	KPL
OPGLZANT	Set završetaka za GOLA L (L+D) - ANTRACIT	KPL
OPGLZZL	Završetak za GOLA L (L+D) - ZLATNI	KPL

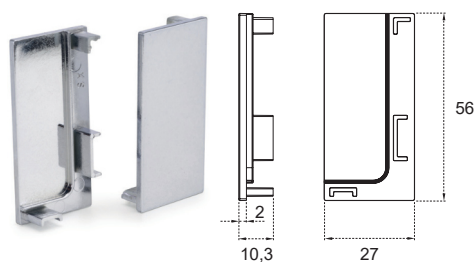

Artikl	Naziv	JM
OPGLZBP	Završetak za GOLA L (L+D) - BIJELI, PUNI	KPL
OPGLZCP	Završetak za GOLA L (L+D) - CRNI, PUNI	KPL
OPGLZP	Završetak za GOLA L (L+D) - PUNI	KPL
OPGLZANTP	Set završetaka za GOLA L (L+D) - ANTRACIT, PUNI	KPL
OPGLZZLP	Završetak za GOLA L (L+D) - ZLATNI, PUNI	KPL

Profili Gola

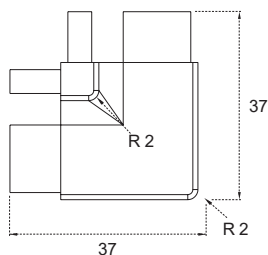

Artikl	Naziv	JM
OPGLKV	Kutnik za GOLA L, vanjski, ALU	KOM
OPGLKVC	Kutnik za GOLA L, vanjski, CRNI	KOM
OPGLKVB	Kutnik za GOLA L, vanjski, BIJELI	KOM

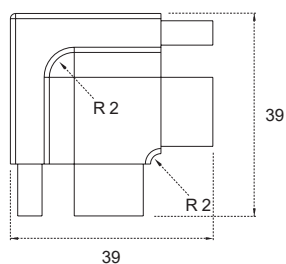

Artikl	Naziv	JM
OPGLKU	Kutnik za GOLA L, unutarnji, ALU	KOM
OPGLKUC	Kutnik za GOLA L, unutarnji, CRNI	KOM
OPGLKUB	Kutnik za GOLA L, unutarnji, BIJELI	KOM

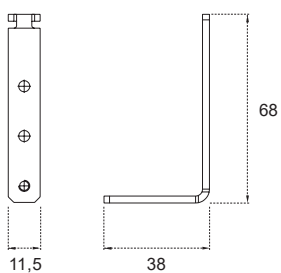
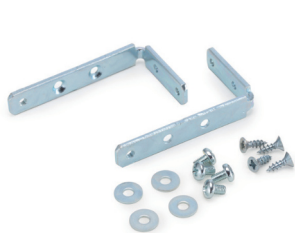

Artikl	Naziv	JM
OPGPK	Kutnik metalni - pričvršćivač Gola profila	KPL

Gola profil C 4,1m

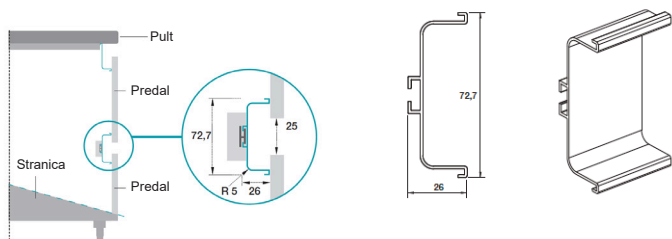

Artikl	Naziv	JM
OPGCPAL	Opes Gola profil C, ALU (4,1 tm)	TM
OPGCPB	Opes Gola profil C, BIJELA (4,1 tm)	TM
OPGCP C	Opes Gola profil C, CRNI (4,1 m)	TM
OPGCPANT	Opes Gola profil C, ANTRACIT (4,1 tm)	TM
OPGCPZL	Opes Gola profil C, ZLATNI (4,1 tm)	TM

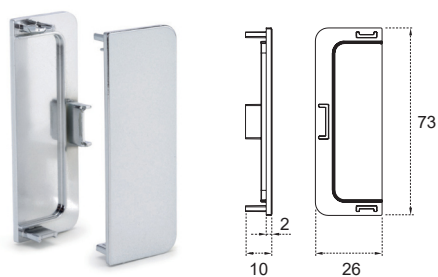

Artikl	Naziv	JM
OPGCZP	Završetak za GOLA C (univerzalni) - ALU, PUNI	KOM
OPGCZBP	Završetak za GOLA C (univerzalni) - BIJELI, PUNI	KOM
OPGCZCP	Završetak za GOLA C (univerzalni) - CRNI, PUNI	KOM
OPGCZANTP	Završetak za GOLA C (univerzalni) - ANTRACIT, PUNI	KOM
OPGCZZLP	Završetak za GOLA C (univerzalni) - ZLATNI, PUNI	KOM

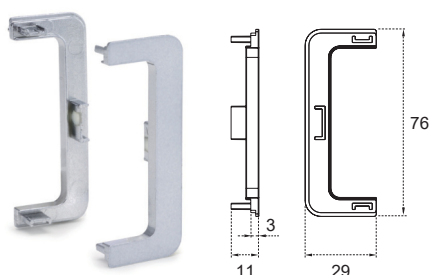

Artikl	Naziv	JM
OPGCZ	Završetak za GOLA C (univerzalni) - ALU	KOM
OPGCZB	Završetak za GOLA C (univerzalni) - BIJELI	KOM
OPGCZC	Završetak za GOLA C (univerzalni) - CRNI	KOM
OPGCZANT	Završetak za GOLA C (univerzalni) - ANTRACIT	KOM
OPGCZZL	Završetak za GOLA C (univerzalni) - ZLATNI	KOM

Profili Gola

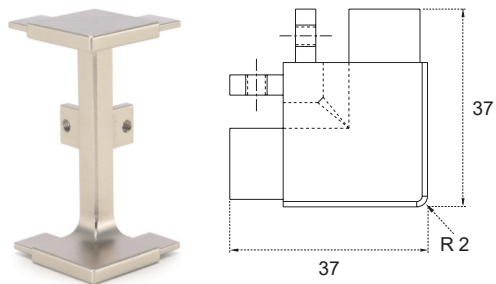

Artikl	Naziv	JM
OPGCKV	Kutnik za GOLA C, vanjski, ALU	KOM
OPGCKVC	Kutnik za GOLA C, vanjski, CRNI	KOM
OPGCKVB	Kutnik za GOLA C, vanjski, BIJELI	KOM

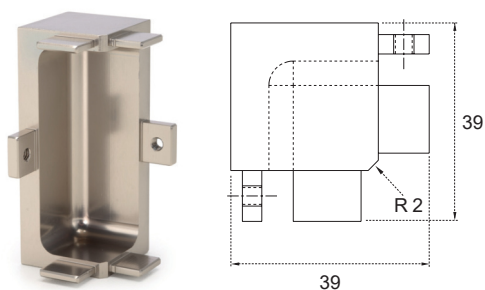

Artikl	Naziv	JM
OPGCKU	Kutnik za GOLA C, unutarnji, ALU	KOM
OPGCKUC	Kutnik za GOLA C, unutarnji, CRNI	KOM
OPGCKUB	Kutnik za GOLA C, unutarnji, BIJELI	KOM



Gola profil za zgornje elemente 4m

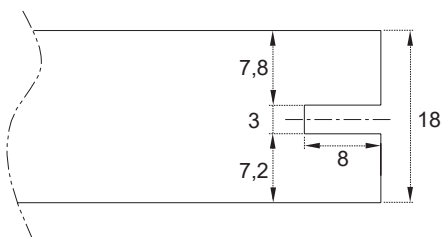
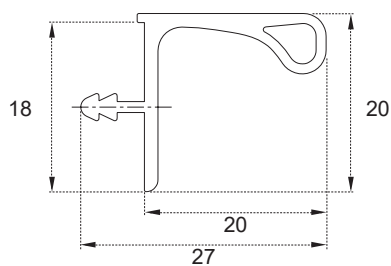

36

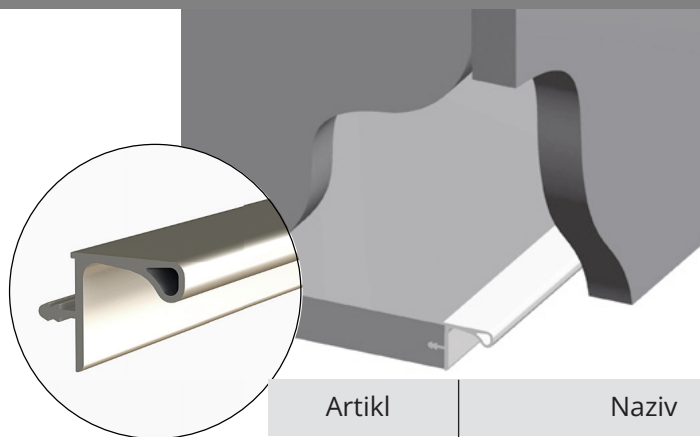

Artikl	Naziv	JM
GOAL268	Opes Gola profil za gornje elemente, ALU (4 m)	TM
GOAL268B	Opes Gola profil za gornje elemente, ALU (4 m), BIJELI	TM
GOAL268ANT	Opes Gola profil za gornje elemente, ANTRACIT-aluminij (4 m)	TM
GOAL268C	Opes Gola profil za gornje elemente, CRNI-aluminij (4 m)	TM
GOAL268ZL	Opes Gola profil za gornje elemente, ALU (4 m), ZLATNI	TM

Gola profil L vertikalni 2,7m

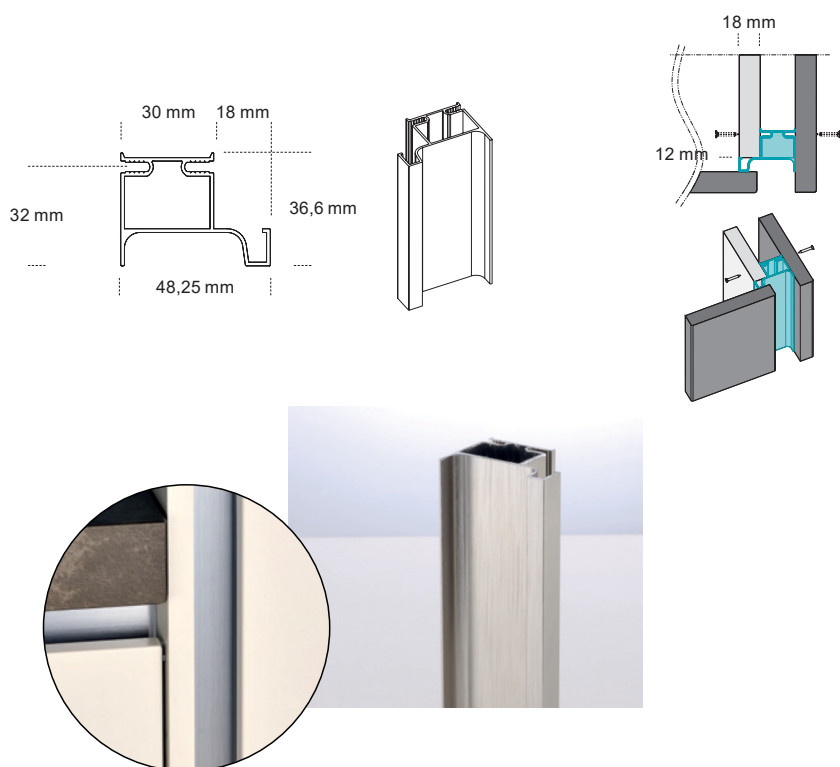

Artikl	Naziv	JM
OPGVLPAL27	Opes Gola vertikalni L profil, ALU 2,7tm	TM
OPGVLPB27	Opes Gola vertikalni L profil ALU, 2,7tm BIJELE	TM
OPGVLPC27	Opes Gola vertikalni L profil ALU, 2,7tm CRNI	TM
OPGVLPZL27	Opes Gola vertikalni L profil ALU, 2,7tm ZLATNI	TM

Gola profil C vertikalni 2,7m

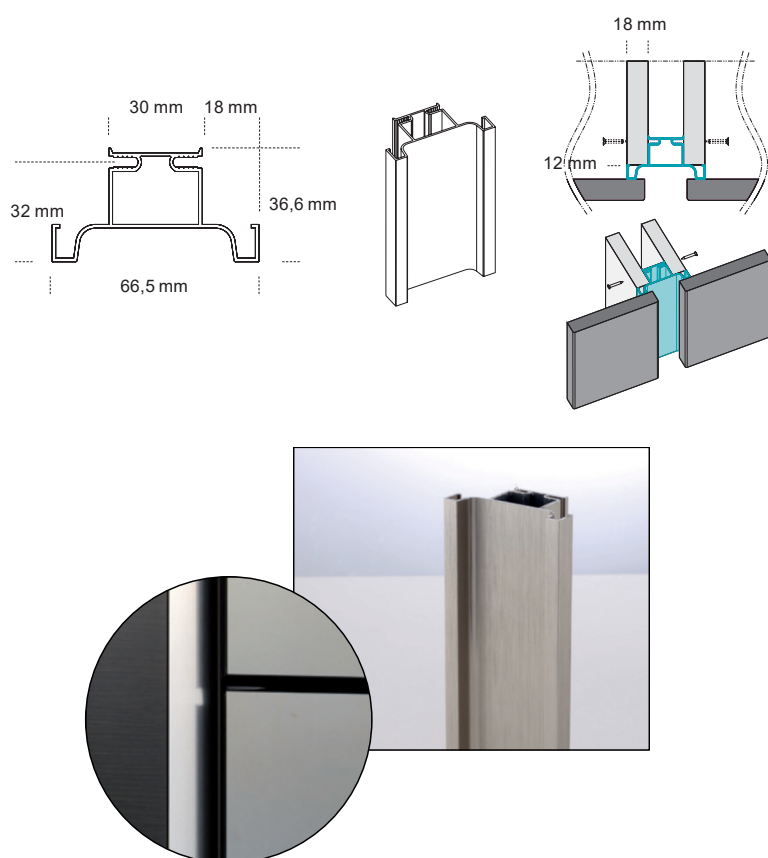

Artikl	Naziv	JM
OPGVCPAL27	Opes Gola verikalni C profil, ALU, 2,7tm	TM
OPGVCPB27	Opes Gola vertikalni C profil ALU, 2,7tm, BIJELE	TM
OPGV CPC27	Opes Gola vertikalni C profil ALU, 2,7tm, CRNI	TM
OPGVCPZL27	Opes Gola vertikalni C profil ALU, 2,7tm, ZLATNI	TM

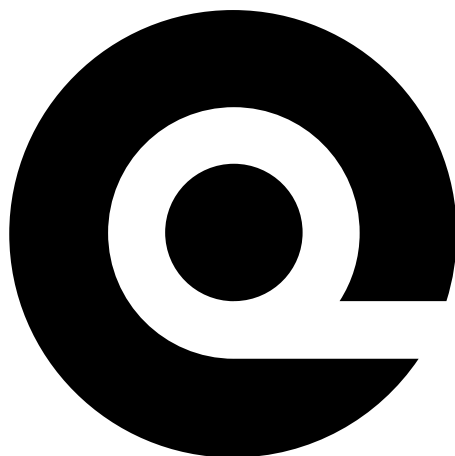

www.blazic.eu
info@blazic.hr

Blažič d.o.o.
Javorska2, Novaki
10431 SvetaNedelja

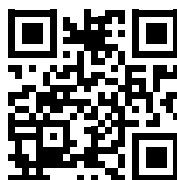

uvijek najnoviji katalogi